

# MMBT5401

TRANSISTOR (PNP)

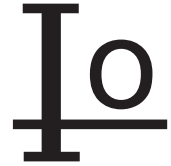

## FEATURES

Complementary to MMBT5551

Ideal for medium power amplification and switching

SOT-23

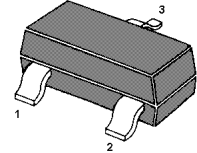

1. BASE
2. EMITTER
3. COLLECTOR

## MAXIMUM RATINGS ( $T_A=25^{\circ}\text{C}$ unless otherwise noted)

Symbol	Parameter	Value	Units
$V_{CB0}$	Collector-Base Voltage	-160	V
$V_{CEO}$	Collector-Emitter Voltage	-150	V
$V_{EBO}$	Emitter-Base Voltage	-5	V
$I_C$	Collector Current -Continuous	-0.6	A
$P_C$	Collector Power Dissipation	0.3	W
$T_j$	Junction Temperature	150	$^{\circ}\text{C}$
$T_{stg}$	Storage Temperature	-55-150	$^{\circ}\text{C}$

## ELECTRICAL CHARACTERISTICS ( $T_{amb}=25^{\circ}\text{C}$ unless otherwise specified)

Parameter	Symbol	Test conditions	MIN	MAX	UNIT
<b>Collector-base breakdown voltage</b>	$V_{(BR)CBO}$	$I_C = -100\mu\text{A}$ , $I_E = 0$	-160		V
<b>Collector-emitter breakdown voltage</b>	$V_{(BR)CEO}$	$I_C = -1\text{mA}$ , $I_B = 0$	-150		V
<b>Emitter-base breakdown voltage</b>	$V_{(BR)EBO}$	$I_E = -10\mu\text{A}$ , $I_C = 0$	-5		V
<b>Collector cut-off current</b>	$I_{CBO}$	$V_{CB} = -120\text{V}$ , $I_E = 0$		-0.1	$\mu\text{A}$
<b>Emitter cut-off current</b>	$I_{EBO}$	$V_{EB} = -4\text{V}$ , $I_C = 0$		-0.1	$\mu\text{A}$
<b>DC current gain</b>	$h_{FE1}$	$V_{CE} = -5\text{V}$ , $I_C = -1\text{mA}$	80		
	$h_{FE2}$	$V_{CE} = -5\text{V}$ , $I_C = -10\text{mA}$	100	300	
	$h_{FE3}$	$V_{CE} = -5\text{V}$ , $I_C = -50\text{mA}$	50		
<b>Collector-emitter saturation voltage</b>	$V_{CE(sat)}$	$I_C = -50\text{mA}$ , $I_B = -5\text{mA}$		-0.5	V
<b>Base-emitter saturation voltage</b>	$V_{BE(sat)}$	$I_C = -50\text{mA}$ , $I_B = -5\text{mA}$		-1	V
<b>Transition frequency</b>	$f_T$	$V_{CE} = -5\text{V}$ , $I_C = -10\text{mA}$	100		MHz

## Typical Characteristics

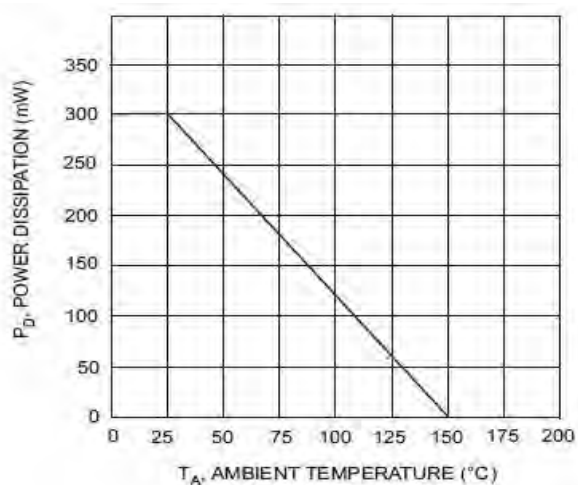

Fig. 1, Max Power Dissipation vs Ambient Temperature

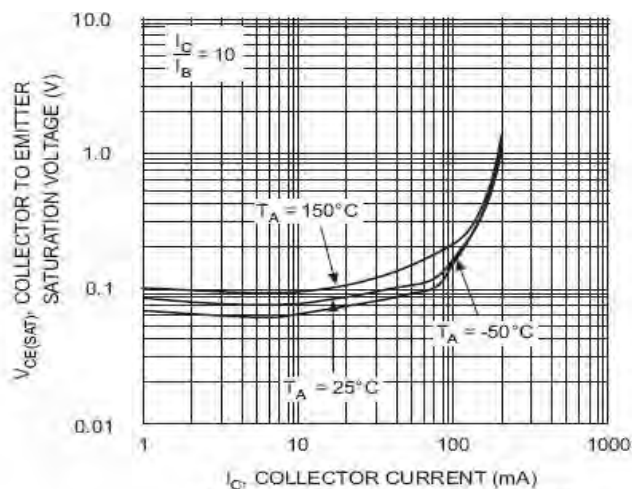

Fig. 2, Collector-Emitter Saturation Voltage vs. Collector Current

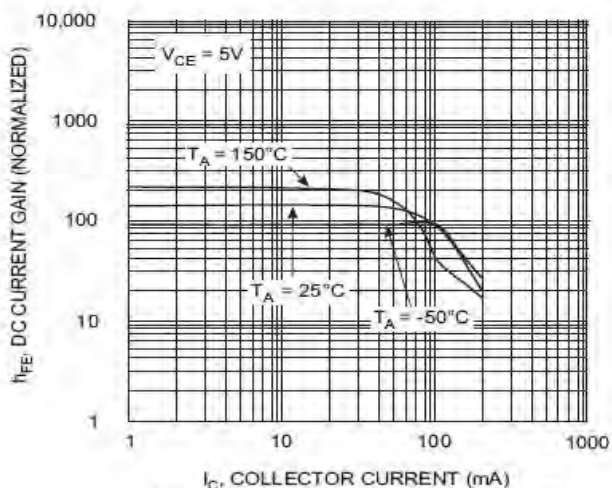

Fig. 3, DC Current Gain vs. Collector Current

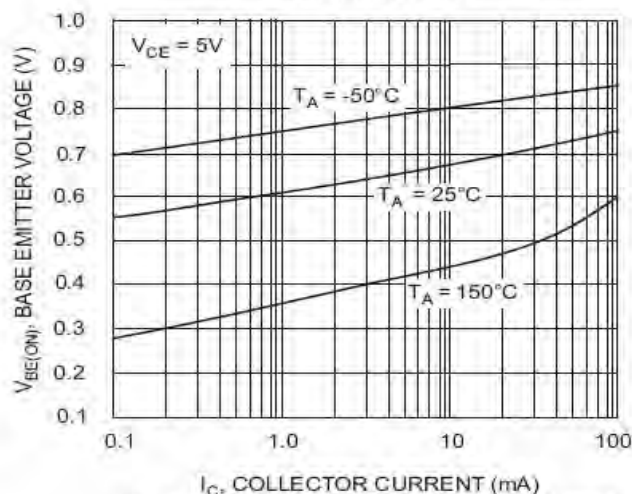

Fig. 4, Base-Emitter Voltage vs. Collector Current

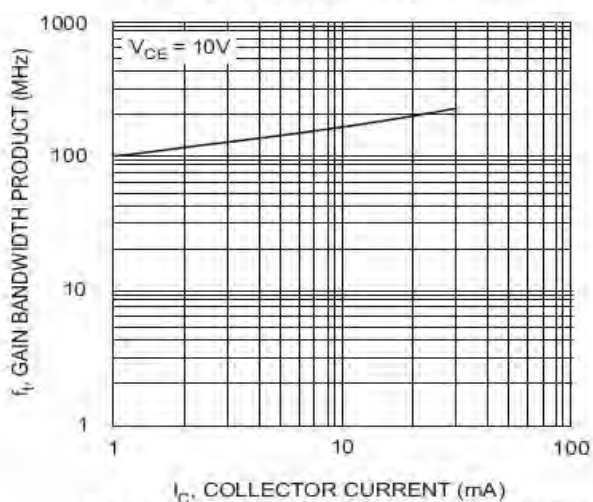
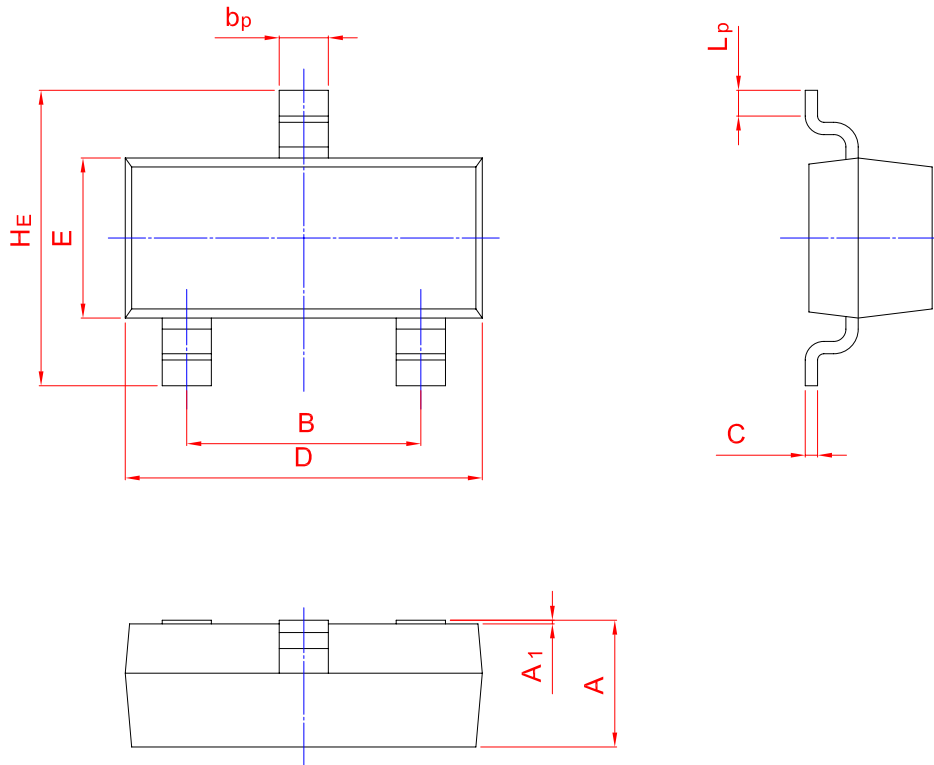
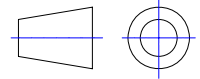

Fig. 5, Gain Bandwidth Product vs Collector Current

# PACKAGE OUTLINE

Plastic surface mounted package; 3 leads

SOT-23



UNIT	A	B	bp	C	D	E	Hε	A1	Lp
mm	1.40	2.04	0.50	0.19	3.10	1.65	3.00	0.100	0.50
	0.95	1.78	0.35	0.08	2.70	1.20	2.20	0.013	0.20