

MMBT2907 / MMBT2907A

PNP Silicon Epitaxial Planar Transistor

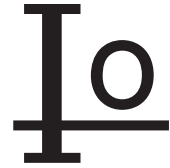

for switching and AF amplifier applications.

The transistor is subdivided into one group according to its DC current gain.

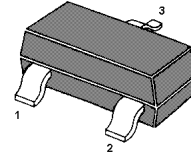

1. Base 2. Emitter 3. Collector
SOT-23 Plastic Package

Absolute Maximum Ratings ($T_a = 25^\circ\text{C}$)

Parameter	Symbol	Value	Unit
Collector Base Voltage	$-V_{\text{CBO}}$	60	V
Collector Emitter Voltage	$-V_{\text{CEO}}$	40 60	V
Emitter Base Voltage	$-V_{\text{EBO}}$	5	V
Collector Current	$-I_{\text{C}}$	600	mA
Power Dissipation	P_{tot}	350	mW
Junction Temperature	T_{j}	150	$^\circ\text{C}$
Storage Temperature Range	T_{stg}	- 55 to + 150	$^\circ\text{C}$

Characteristics at $T_a = 25^\circ\text{C}$

Parameter	Symbol	Min.	Max.	Unit	
DC Current Gain at $-I_C = 0.1\text{ mA}$, $-V_{CE} = 10\text{ V}$ at $-I_C = 1\text{ mA}$, $-V_{CE} = 10\text{ V}$ at $-I_C = 10\text{ mA}$, $-V_{CE} = 10\text{ V}$ at $-I_C = 150\text{ mA}$, $-V_{CE} = 10\text{ V}$ at $-I_C = 500\text{ mA}$, $-V_{CE} = 10\text{ V}$	MMBT2907	h_{FE}	35	-	-
	MMBT2907A	h_{FE}	75	-	-
	MMBT2907	h_{FE}	50	-	-
	MMBT2907A	h_{FE}	100	-	-
	MMBT2907	h_{FE}	75	-	-
	MMBT2907A	h_{FE}	100	-	-
	MMBT2907	h_{FE}	100	300	-
	MMBT2907A	h_{FE}	30	-	-
Collector Base Cutoff Current at $-V_{CB} = 50\text{ V}$	MMBT2907	$-I_{CBO}$	-	20	nA
	MMBT2907A	$-I_{CBO}$	-	10	nA
Collector Base Breakdown Voltage at $-I_C = 10\text{ }\mu\text{A}$		$-V_{(BR)CBO}$	60	-	V
Collector Emitter Breakdown Voltage at $-I_C = 10\text{ mA}$	MMBT2907	$-V_{(BR)CEO}$	40	-	V
	MMBT2907A	$-V_{(BR)CEO}$	60	-	V
Emitter Base Breakdown Voltage at $-I_E = 10\text{ }\mu\text{A}$		$-V_{(BR)EBO}$	5	-	V
Collector Saturation Voltage at $-I_C = 150\text{ mA}$, $-I_B = 15\text{ mA}$ at $-I_C = 500\text{ mA}$, $-I_B = 50\text{ mA}$		$-V_{CE(sat)}$	-	0.4	V
		$-V_{CE(sat)}$	-	1.6	V
Base Saturation Voltage at $-I_C = 150\text{ mA}$, $-I_B = 15\text{ mA}$ at $-I_C = 500\text{ mA}$, $-I_B = 50\text{ mA}$		$-V_{BE(sat)}$	-	1.3	V
		$-V_{BE(sat)}$	-	2.6	V
Gain Bandwidth Product at $-I_C = 50\text{ mA}$, $-V_{CE} = 20\text{ V}$, $f = 100\text{ MHz}$		f_T	200	-	MHz
Collector Output Capacitance at $-V_{CB} = 10\text{ V}$, $f = 1\text{ MHz}$		C_{ob}	-	8	pF
Turn-on Time at $-V_{CC} = 30\text{ V}$, $-I_C = 150\text{ mA}$, $-I_{B1} = 15\text{ mA}$		t_{on}	-	45	ns
Delay Time at $-V_{CC} = 30\text{ V}$, $-I_C = 150\text{ mA}$, $-I_{B1} = 15\text{ mA}$		t_d	-	10	ns
Rise Time at $-V_{CC} = 30\text{ V}$, $-I_C = 150\text{ mA}$, $-I_{B1} = 15\text{ mA}$		t_r	-	40	ns
Turn-off Time at $-V_{CC} = 6\text{ V}$, $-I_C = 150\text{ mA}$, $-I_{B1} = -I_{B2} = 15\text{ mA}$		t_{off}	-	100	ns
Storage Time at $-V_{CC} = 6\text{ V}$, $-I_C = 150\text{ mA}$, $-I_{B1} = -I_{B2} = 15\text{ mA}$		t_s	-	80	ns
Fall Time at $-V_{CC} = 6\text{ V}$, $-I_C = 150\text{ mA}$, $-I_{B1} = -I_{B2} = 15\text{ mA}$		t_f	-	30	ns

Typical Pulsed Current Gain vs Collector Current

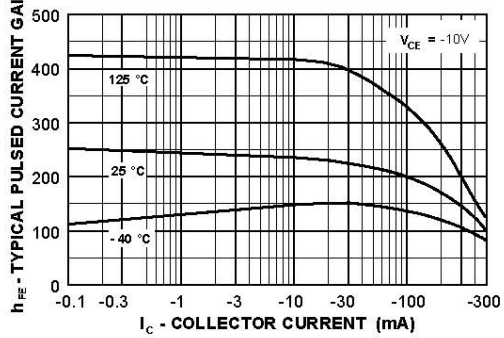

Collector-Emitter Saturation Voltage vs Collector Current

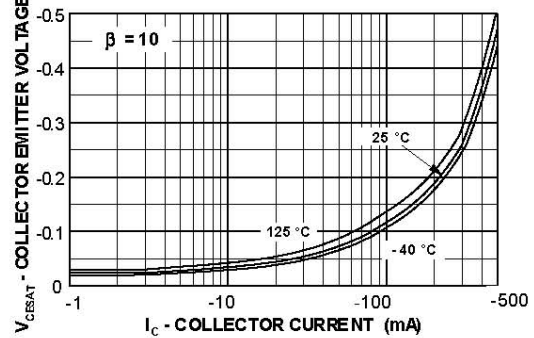

Base-Emitter Saturation Voltage vs Collector Current

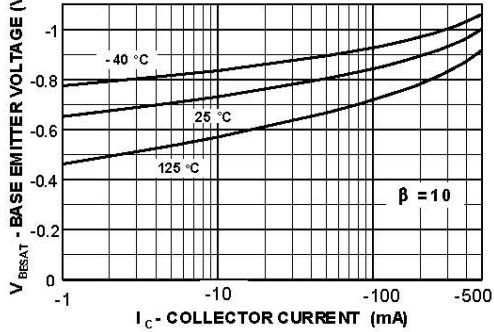

Base Emitter ON Voltage vs Collector Current

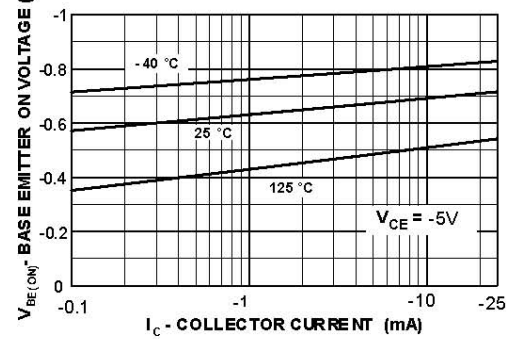

Collector-Cutoff Current vs Ambient Temperature

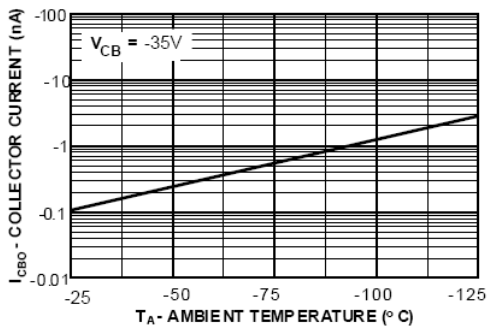

Input and Output Capacitance vs Reverse Bias Voltage

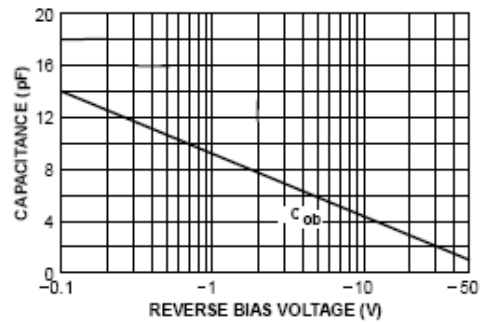

P_CT_a

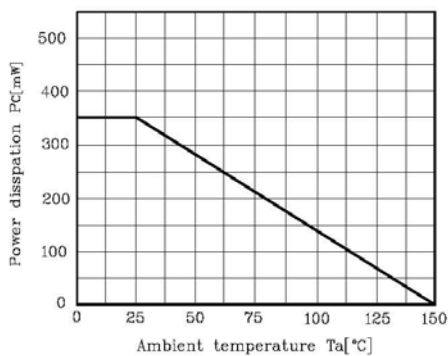

PACKAGE OUTLINE

Plastic surface mounted package; 3 leads

SOT-23

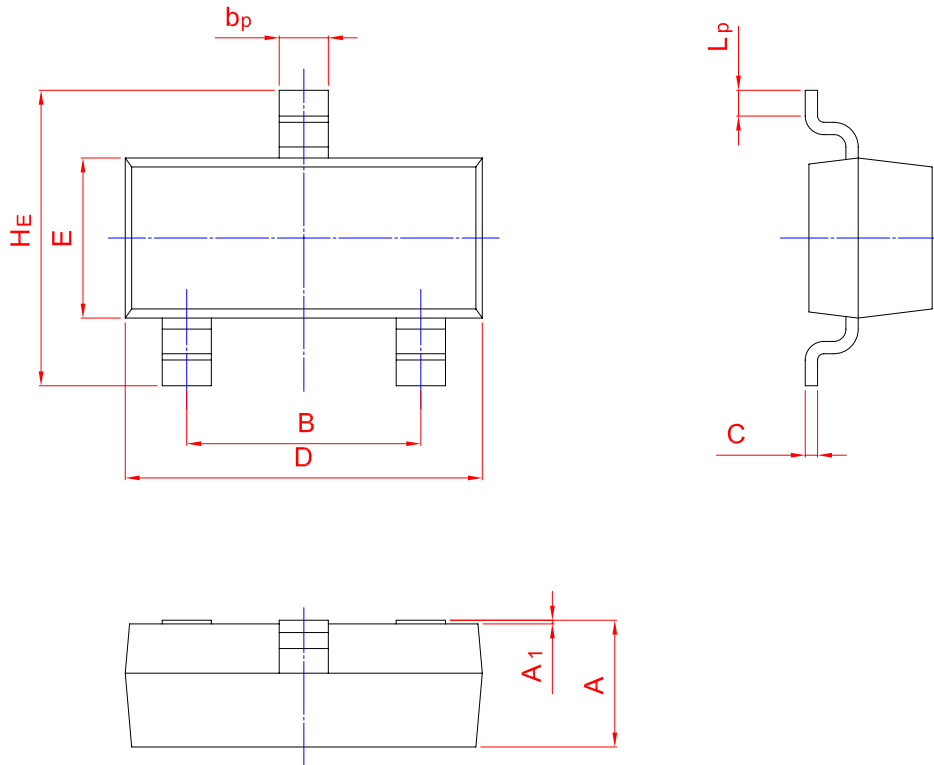
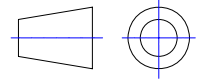

UNIT	A	B	bp	C	D	E	Hε	A1	Lp
mm	1.40	2.04	0.50	0.19	3.10	1.65	3.00	0.100	0.50
	0.95	1.78	0.35	0.08	2.70	1.20	2.20	0.013	0.20